



Model 730

Vacuum Capacitance Manometer

Features

- Chemical resistive nickel alloy design
- Precise low vacuum measurements
- Industry standard connections
- High accuracy: $\pm 0.5\%$ of reading Std., $\pm 0.25\%$ optional
- Tensioned diaphragm provides superior performance
- Wide compensated operating temperature
- Fast response time with low circuit noise
- Insensitive to environmental changes
- Exceptional overpressure capability
- CE & RoHS compliant

Applications

- Semiconductor
- Petrochemical
- Plasma sterilizers
- Vacuum packaging

Setra's Model 730 is a high accuracy absolute capacitance manometer (also referred to as Capacitance Diaphragm Gauge (CDG)), for measuring low vacuum pressure ranges that are critical to the control of processes in photovoltaic, semiconductor and industrial markets. The 730 utilizes welded, all nickel alloy wetted components which provides capability with the most aggressive process media. Its high frequency electronics design is fully RoHS compliant and yields extremely low noise, while maintaining the fast response time required for today's critical control applications. External noise rejection, fast warm-up, resistance to environmental effects, and long term stability are unmatched by competing models.

High performance for demanding applications

The Model 730 capacitance manometer uses a rigid single electrode variable capacitance sensing element resulting in high over pressure capability and superior long term stability. It's percent of reading accuracy, low hysteresis, and high resolution provides a wide dynamic range, making the 730 an ideal fir for measuring and controlling critical manufacturing processes.

Process compatible nickel alloy sensor

The 730 is designed using nickel alloy for all its wetted parts. Nickel alloy is highly resistive to the corrosive media used in semiconductor and industrial vacuum processes. Their material, along with the all welded construction, ensures long life in the most demanding applications.

Direct pressure measurement

Unlike some vacuum measuring technologies, the Model 730 capacitance manometer measures direct pressure; force/unit area. Its 0-5 or 0-10 VDC analog output signal is proportional to the applied pressure and independent of the process gas composition.



Specifications

Performance data

Accuracy	±0.5% of reading ±0.25% of reading (Opt)
Response time	<20 ms
Resolution	Infinite, limited only by output noise level (≤0.005% FS)

Thermal effects

Compensated range	0° to +50°C
Zero shift	±0.25% FS/50°C
Span shift	±1.35% Rdg/ 50°C
Long term stability	0.5% FS/1 YR, excluding environmental effects

Electrical data (voltage)

Excitation/Output ¹	12 to 30 VDC for 0-10 VDC 9 to 30 VDC for 0-5 VDC
Current consumption	<10 mA max
Output load	>10 kΩ Load
Output impedance	<1 ohm
Circuit	3-Wire

¹Includes non-linearity, non-repeatability and hysteresis
²Units calibrated at nominal 66°F. Maximum thermal error computed from this datum.
³±1.0% FS/yr for ranges <100 Torr full scale when operated at 80°C
⁴Calibrated into a 50K ohm load, operable into a 5000 ohm load or greater

Specifications subject to change without notice.

Physical description

Pressure fittings	See ordering information
Wetted material	Nickel alloy
Electrical connection	5-Pin Screw terminal, 9-Pin D-Sub, or 15-Pin D-Sub on 6" pigtail
Case	Stainless steel
Cavity volume	<6.0 ccl
Weight (approx.)	<250 gl

Pressure media

Gases or liquids compatible with nickel alloy. Nickel alloy wetted material is for 0.5" tube option only. Other fitting options will add stainless steel.

Environmental data

Temperature	0° to +80°C
-------------	-------------

Approvals

CE, RoHS

Ordering information

Example part number: 730G010TA4T2BD9K

Model 730, 10 Torr pressure range, Absolute pressure type, 0.5" OD Tube fitting, 0-5VDC output, 9-Pin D-Sub termination, ±0.5% of Reading accuracy

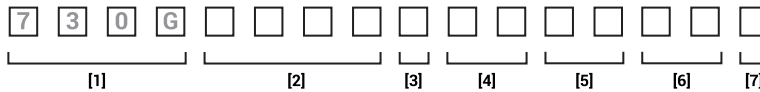

[1]	[2]	[3]	[4]	[5]	[6]	[7]
Model	Pressure range ¹	Pressure type	Fitting	Output	Elec. termination	Accuracy
730G Model 730	010T 10 Torr 020T 20 Torr 100T 100 Torr 200T 200 Torr 10CT 1000 Torr 010M 10 mBar ¹ 020M 20 mBar 100M 100 mBar 10CM 1000 mBar 001K 1 kPa ¹ 002K 2 kPa 010K 10 kPa 100k 100 kPa	A Absolute	4T 0.5"OD tube N0 ISO NW10 N1 ISO NW16 N2 ISO NW25 D8 8 VCR® Int. swivel 2T 0.25" OD tube D4 4 VCR Int. swivel 2M 0.25" NPT Ext.	2B 0-5 VDC 2C 0-10 VDC	D9 9-pin D-Sub T1 Terminal strip D7 15-pin D-Sub on 6" pigtail	K ±0.5% of reading A ±0.25% of reading J ±1% of reading

Dimensions

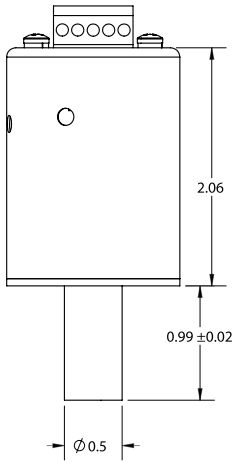
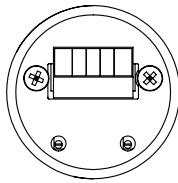

Elec. termination code "4T"

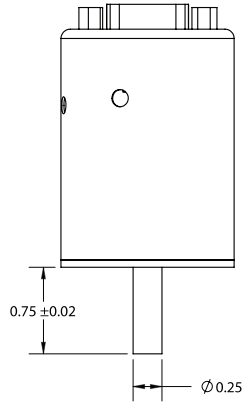
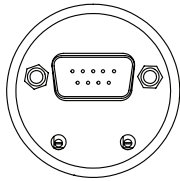

Elec. termination code "2T"

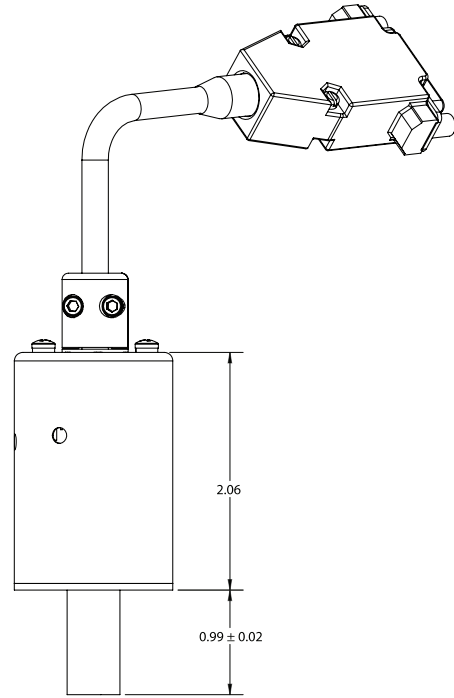

Elec. termination code "4T" with fitting code "D7"

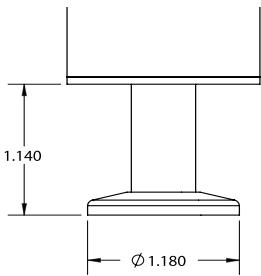

Fitting code "N0"

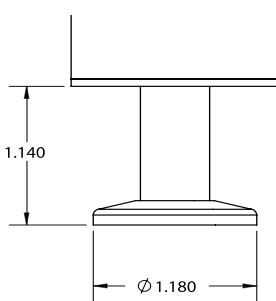

Fitting code "N1"

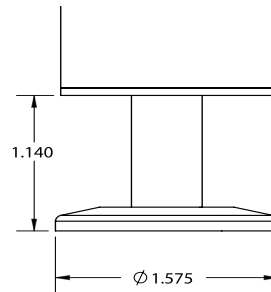

Fitting code "N2"

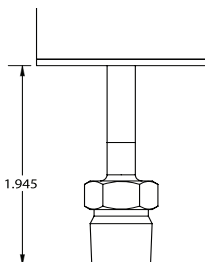

Fitting code 2M

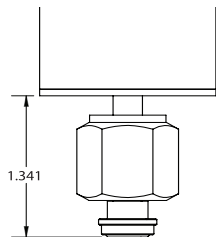

Fitting code D4

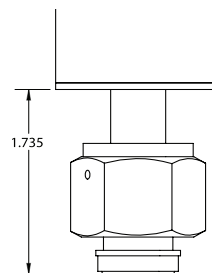

Fitting code D8



Setra Systems, Inc.
159 Swanson Road
Boxborough, MA 01719

800.257.3872
www.setra.com



© Setra Systems, Inc. All rights reserved.

The Setra Systems name and logo
are trademarks of Setra Systems, Inc.